



## ML22Q244

ADPCM Speech Synthesis LSI

### ■ GENERAL DESCRIPTION

ML22Q244 is a speech synthesis LSI that incorporates Flash for storing sound code data, and can be controlled with a standalone interface.

By integrating D-class speaker amplifier, solution required for sound output is made possible with single chip.

- Playback time

Product name	Flash capacity (bit)	Maximum playback time (sec) (at $f_s^{*1} = 6.4 \text{ kHz}$ )	
		HQ-ADPCM	16-bit Straight PCM
ML22Q244	692K (when 30 phrases are selected)	34.6	6.92
	688K (when 62 phrases are selected)	34.4	6.88

Notes: Flash capacity shows the numerical value of only a sound area

\*1: Sampling frequency

- Speech synthesis algorithm: HQ-ADPCM  
4-bit ADPCM2  
8-bit Nonlinear PCM  
8-bit / 16-bit Straight PCM  
(Can be specified for each phrase)
- Flash capacity: 692 Kbit (30 phrases selection), 688Kbit ( 62 phrases selection)
- Sampling frequency (Fs): 6.4kHz, 8.0kHz, 10.7kHz, 12.8kHz, 16.0kHz,  
21.3kHz, 25.6kHz, 32.0kHz  
(Can be specified for each phrase)
- Speaker driving amplifier: D-class amplifier (driven by 8 Ω)
- CPU command interface: Standalone interface (built-in noise removal function)
- Maximum number of phrases: 30 phrases or 62 phrases
- Disconnection detection function
- Speaker pin short detection function
- Source oscillation frequency: 8.192MHz (Typ) (internal)
- Power supply voltage: 2.0 to 5.5 V
- Flash memory rewritable time: 100 times
- Operating temperature range: -40°C to +85°C
- Package: 20-pin plastic TSSOP  
ML22Q244-NNNTD/ML22Q244-xxxTD  
(xxx: ROM code No.)

\*1



HQ-ADPCM is a high sound quality audio compression technology of "Ky's".  
"Ky's" is a Registered trademark of National Universities corporate Kyushu  
Institute of Technology



The following table shows the differences from ML22Q234, ML22Q254.

Parameter	ML22Q244 (This product)	ML22Q234	ML22Q254
MCU interface	Standalone	Clock synchronization Serial	I <sup>2</sup> C
Flash capacity	692 Kbit (when 30 phrases are selected) 688 Kbit (when 62 phrases are selected)	676 Kbit (when 30 phrases are selected) 672 Kbit (when 62 phrases are selected)	←
Speech synthesis algorithm	HQ-ADPCM 4-bit ADPCM2 8-bit Nonlinear PCM 8-bit Straight PCM 16-bit Straight PCM	←	←
Maximum number of phrases:	30/62	←	←
Sampling frequency (kHz)	6.4/8.0/10.7/12.8/ 16.0/21.3/25.6/32.0	←	←
Clock frequency	8.192 MHz (internal oscillation)	←	←
Low-pass filter	FIR interpolation filter	←	←
Speaker driving amplifier	D-class amplifier	←	←
Speaker driving amplifier output load	8Ω	←	←
Speaker driving amplifier output voltage	1 W	←	←
Edit ROM function	Yes	←	←
Volume control	Code setting : 32 levels (Including Mute)	Code setting : 32 levels (Including Mute) Command setting : 31 levels	←
Silence insertion	4 ms to 1024 ms (4 ms/step)	←	←
Repeat function	Yes	←	←
Flash memory access function by MCU	No	Yes	←
Power supply voltage	2.0 to 5.5 V	←	←
Operating temperature range	-40 to +85°C	←	←
Package	20-pin TSSOP	←	←

■ BLOCK DIAGRAMS

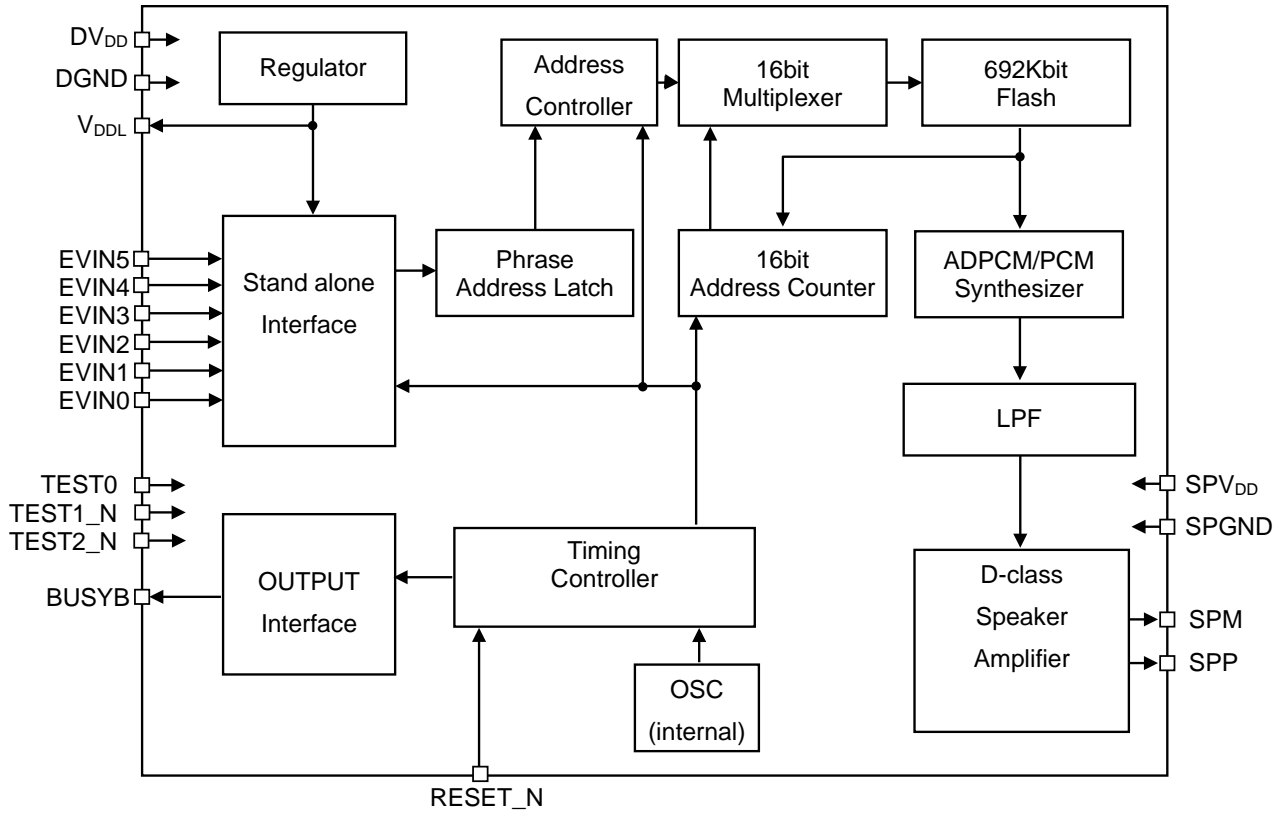

■ PIN CONFIGURATIONS (TOP VIEW)

20-Pin Plastic TSSOP

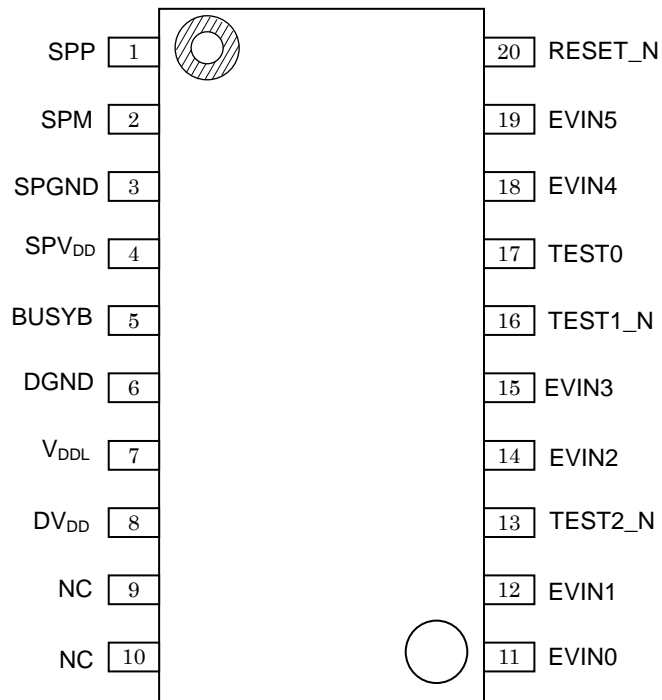

NC : Unused pin

## ■ PIN DESCRIPTION

Pin	Symbol	I/O	Initial value (At the RESET_N Input)	Initial value (At standby)	Description
1	SPP	O	Hi-Z	Hi-Z	Positive (+) output pin of the speaker amplifier built-in
2	SPM	O	Hi-Z	Hi-Z	Negative (-) output pin of the speaker amplifier built-in.
3	SPGND	-	-	-	Ground pin for the speaker amplifier.
4	SPV <sub>DD</sub>	-	-	-	Power supply pin for the speaker amplifier Connect a bypass capacitor of 1 $\mu$ F $\pm$ 30% or more between this pin and SPGND pin.
5	BUSYB	O	Hi-Z	*1	BUSY output pin. When BUSYB use mode is set, the "L" level is outputted during playback. When disconnection is detected with disconnection detection function, the "L" level is outputted. BUSYB unused mode and logic inversion can be set with Speech LSI Utility.
6	DGND	-	-	-	Digital ground pin.
7	V <sub>DDL</sub>	-	-	-	Regulator output pin for internal logic circuitry. Connect a capacitor of 1 $\mu$ F $\pm$ 30% between this pin and DGND pin
8	DV <sub>DD</sub>	-	-	-	Digital power supply pin. Connect a capacitor of 1 $\mu$ F $\pm$ 30% or more between this pin and DGND pin.
11	EVIN0	I	*1	*1	Command input pin. Sound can be played back and stopped based on a change in a signal input to EVIN5-0 pin. The pin state can be set with Speech LSI Utility. Select pull-down input, pull-up input, or high impedance input
12	EVIN1	I			
14	EVIN2	I			
15	EVIN3	I			
18	EVIN4	I			
19	EVIN5	I			
13	TEST2_N	I	1	1	Input pin for testing. This pin has a pull-up resistor built in. Fix this pin to DV <sub>DD</sub> .
16	TEST1_N	I	1	1	Input pin for testing. This pin has a pull-up resistor built in. Fix this pin to DV <sub>DD</sub> .
17	TEST0	I/O	0	0	Input/output pin for testing. Non connection.
20	RESET_N	I	0	1	Reset input pin. This pin has a pull-up resistor built in. Input "L" level for initialization, when power is turned on, or when voltage falls below recommended operation power supply voltage range. After the power supply voltage is stable, drive this pin to "H" level.
9	N.C.	-	-	-	Unused pin.
10					Leave this pin open.

\*1: This value depends on Speech LSI Utility setting. Please refer to a "Code Option Setting Item" for details.

## ■ ABSOLUTE MAXIMUM RATINGS

(DGND = SPGND = 0 V)

Parameter	Symbol	Condition	Rating	Unit
Power supply voltage	DV <sub>DD</sub> SPV <sub>DD</sub>	Ta = 25 °C	-0.3 to +6.5	V
Internal logic power supply voltage	V <sub>DDL</sub>		-0.3 to +2.0	V
Input voltage	V <sub>IN</sub>		-0.3 to V <sub>DD</sub> +0.3	V
Power dissipation	P <sub>D</sub>		1	W
Output short-circuit current	I <sub>SC1</sub>	Applied to pin other than SPP or SPM	-12 to +11	mA
	I <sub>SC2</sub>	SPP pin, SPM pin	600	mA
Storage temperature	T <sub>STG</sub>	-	-55 to +150	°C

## ■ RECOMMENDED OPERATING CONDITIONS

(DGND = SPGND = 0 V)

Parameter	Symbol	Condition	Range	Unit
Power supply voltage	DV <sub>DD</sub> SPV <sub>DD</sub>	-	2.0 to 5.5	V
		Flash memory write	2.2 to 5.5	
Flash memory rewrite cycles <sup>**1</sup>	N	-	100	times
Operating temperature range	T <sub>OP1</sub>	-	-40 to +85	°C
	T <sub>OP2</sub>	Flash memory write	0 to +40	
Capacitor externally connected to DV <sub>DD</sub> pin	C <sub>V</sub>	-	1±30% or more	μF
Capacitor externally connected to SPV <sub>DD</sub> pin	C <sub>SV</sub>	-	1±30% or more	μF
Capacitor externally connected to V <sub>DDL</sub> pin	C <sub>L</sub>	-	1±30%	μF
FLASH Memory write cycle	Y <sub>DR</sub>	-	15	years

<sup>\*\*1</sup>: It means one erase and one program. Even when erasing is interrupted, it counts as one time.

## ■ ELECTRICAL CHARACTERISTICS

### ● DC Characteristics

 $DV_{DD} = SPV_{DD} = 2.0 \text{ to } 5.5 \text{ V}, DGND = SPGND = 0 \text{ V}, Ta = -40 \text{ to } +85^{\circ}\text{C}$ 

Parameter	Symbol	Condition	Min.	Typ.	Max.	Unit
"H" input voltage	$V_{IH}$	-	$0.7 \times DV_{DD}$	-	$DV_{DD}$	V
"L" input voltage	$V_{IL}$	-	0	-	$0.3 \times DV_{DD}$	V
"H" output voltage 1	$V_{OH1}$	$I_{OH} = -0.5 \text{ mA}$	$DV_{DD} - 0.5$	-	-	V
"L" output voltage 1	$V_{OL1}$	$I_{OL} = 0.5 \text{ mA}$	-	-	0.5	V
"H" input current 1	$I_{IH1}$	$V_{IH} = DV_{DD}$	-	-	1	$\mu\text{A}$
"H" input current 2	$I_{IH2}$	$V_{IH} = DV_{DD}$ TEST0 pin	0.02	0.3	1.5	mA
"H" input current 3	$I_{IH3}$	$V_{IH} = DV_{DD}$ EVIN5-0 terminal pull-up input is set	2	30	250	$\mu\text{A}$
"L" input current 1	$I_{IL1}$	$V_{IL} = DGND$	-1	-	-	$\mu\text{A}$
"L" input current 2	$I_{IL2}$	$V_{IL} = DGND$ RESET_N pin, TEST1_N	-1.5	-0.3	-0.02	mA
"L" input current 3	$I_{IL3}$	$V_{IL} = DGND$ TEST2_N EVIN5-0 terminal pull-up input is set	-250	-30	-2	$\mu\text{A}$
"H" output current 1	$I_{OOH1}$	$VOH = DV_{DD} = SPV_{DD}$ (High impedance) BUSYB, SPP, SPM pin	-	-	1	$\mu\text{A}$
"H" output current 2	$I_{OOH2}$	$VOH = DV_{DD}$ (Nch Open drain) BUSYB pin	-	-	1	$\mu\text{A}$
"L" output current 1	$I_{OOL1}$	$VOL = DGND = SPGND$ (High impedance) BUSYB, SPP, SPM pin	-1	-	-	$\mu\text{A}$
"L" output current 2	$I_{OOL2}$	$VOL = DGND$ (Pch Open drain) BUSYB pin	-1	-	-	$\mu\text{A}$
Supply current during playback	$I_{DD1}$	No output load $DV_{DD} = SPV_{DD} = 3.0 \text{ V}$	-	3.0	6.0	mA
	$I_{DD2}$	No output load $DV_{DD} = SPV_{DD} = 5.0 \text{ V}$	-	5.0	9.0	
Supply current during stabilizing chattering	$I_{DDC1}$	$DV_{DD} = SPV_{DD} = 5.0 \text{ V}$	-	2.0	3.5	mA
Standby supply current	$I_{DDS1}$	$Ta \leq 50^{\circ}\text{C}$	-	0.5	3.0	$\mu\text{A}$
	$I_{DDS2}$	$Ta \leq 85^{\circ}\text{C}$	-	0.5	8.0	
Source oscillation frequency	$f_{OSC}$	-10 to $+50^{\circ}\text{C}$	8.069	8.192	8.315	MHz
		-40 to $+85^{\circ}\text{C}$	7.946	8.192	8.438	

### ● Characteristics of Analog Circuitry

 $DV_{DD} = SPV_{DD} = 2.0 \text{ to } 5.5 \text{ V}, DGND = SPGND = 0 \text{ V}, Ta = -40 \text{ to } +85^{\circ}\text{C}$ 

Parameter	Symbol	Condition	Min.	Typ.	Max.	Unit
SPM, SPP output load resistance	$R_{LSP}$	-	8	-	-	$\Omega$
Speaker amplifier output voltage	$P_{SPO}$	$SPV_{DD} = 5.0 \text{ V}$ , Sin wave $f = 1 \text{ kHz}$ $R_{LSP} = 8 \Omega$ , THD $\geq 10\%$	-	1.0	-	W

- Power-on/Shutdown Sequence

 $DV_{DD} = SPV_{DD} = 2.0 \text{ to } 5.5 \text{ V}, DGND = SPGND = 0 \text{ V}, Ta = -40 \text{ to } +85^{\circ}\text{C}$ 

Parameter	Symbol	Condition	Min.	Typ.	Max.	Unit
RESET_N input pulse width at Power on	trSTR	-	100	-	-	μs
RESET_N input pulse width at shut down	trSTF	-	0	-	-	μs

- AC Characteristics

 $DV_{DD} = SPV_{DD} = 2.0 \text{ to } 5.5 \text{ V}, DGND = SPGND = 0 \text{ V}, Ta = -40 \text{ to } +85^{\circ}\text{C}$ 

Parameter	Symbol	Condition	Min.	Typ.	Max.	Unit
Initialization time after reset release	t <sub>INIT</sub>	-	-	-	65	ms
Oscillation stabilization time	t <sub>PUP1</sub>	-	-	1	2	ms
Playback time	t <sub>VCYC</sub>	-	20	-	-	ms
Chattering removal time <sup>*1</sup>	t <sub>SP</sub>	Initial value (08 h)	Typ.-2	16	Typ.+2	ms
Command processing time	t <sub>B1</sub>	-	-	-	400	μs
Oscillation stop time, after playback	t <sub>OSST</sub>	-	-	-	500	μs
Next command transmit time□ In the case of the playback	t <sub>NCM</sub>	-	-	-	10	ms
Next command transmit time after shifting to a standby state	t <sub>CMS</sub>	-	50	-	-	ns
Disconnection judging by the DISCONNECT command start time	t <sub>DCDS</sub>	-	1.5	-	-	ms
Disconnection judging by the DISCONNECT command end time	t <sub>DCDE</sub>	-	-	-	1	s
BUSYB change time from "L" to "H", after over-current detection of a speaker amplifier	t <sub>SD</sub>	-	-	-	80	μs
Processing time before playback start	t <sub>PLBF</sub>	-	0.3	-	2.1	ms
Processing time after playback start	t <sub>PLAF</sub>	-	0.15	-	1.2	ms
Fade-out time at Change Immediately mode or Change Immediately Once mode	t <sub>FDO</sub>	-	-	22	-	ms

\*1: Can be set within a range from 0 ms to 62 ms with Speech LSI Utility.

Note: Output pin load capacitance = 45 pF (max.)



■ PLAYBACK FUNCTION

● Standalone interface

Standby is canceled by a change in a signal input to the EVIN5-0 pin, and after the chattering removing period, an operation corresponding to a command indicated by the EVIN5-0 pin starts.

The pin status of the EVIN5-0 can be selected among high-impedance input (Hi-Z), pull-down input (PullDown), and pull-up input (PullUp).

The pin status of the EVIN5-0 pin is selected using Speech LSI Utility. Please refer to a "Code Option Setting Item" for details.

● Chattering removal time

Chattering removal time can be set for preventing erroneous operation due to chattering when the EVIN5-0 pin changes. The time can be set from 2 ms to 62 ms (setting value: 01h to 1Fh) in increments of 2 ms. The initial value is 16 ms (08h).

$$\text{Chattering removal time} = (2^4 \cdot \text{bit4} + 2^3 \cdot \text{bit3} + 2^2 \cdot \text{bit2} + 2^1 \cdot \text{bit1} + 2^0 \cdot \text{bit0}) \cdot 2 \text{ ms}$$

Set a setting value 10h to set the time to be 32 ms.

$$\text{Chattering removal time} = 2^4 \cdot 1 + 2^3 \cdot 0 + 2^2 \cdot 0 + 2^1 \cdot 0 + 2^0 \cdot 0 \text{ )} \cdot 4 \text{ ms} = 8 \cdot 2 \text{ ms} = 32 \text{ ms}$$

The chattering removal time is selected using Speech LSI Utility. Please refer to a "Code Option Setting Item" for details.

● Speech synthesis algorithm

Supporting four types of Speech Synthesis algorithms, which are HQ-ADPCM, 4bit ADPCM2, 8-bit nonlinear PCM, 8-bit Straight PCM, and 16-bit Straight PCM. Any of these can be selected based on the characteristics of the sound to be played back.

Speech Synthesis method	Compression rate <sup>*1</sup>	Suitable waveform	Characteristics
HQ-ADPCM	1/5	Sound including high frequency components (such as sound effects)	4bit ADPCM2 algorithm is improved. Adopting variable bit length enables high sound quality and high data compression.
4-bit ADPCM2	1/4	Normal voice sound wave	Unique scheme which is a refined version of 4bit ADPCM Offers higher sound quality with better waveform followability.
8-bit Nonlinear PCM	1/2	Sound including high frequency components (such as sound effects)	A part around the center of the waveform is played back with a sound quality equivalent to 10 bits.
8-bit Straight PCM	1/2		Normal 8-bit Straight PCM.
16-bit Straight PCM	1		Normal 16-bit Straight PCM.

\*1: When the same sampling frequency is used.

- Memory Allocation and Creating Sound Code Data

The sound code data consists of a sound management area, a sound data area, and an edit ROM area.

The sound control area manages setting information for 30 phrases or 62 phrases.

The sound area contains actual waveform data.

The edit ROM area contains data for effective use of sound data. For the details, refer to the section of "Edit ROM Function". The edit ROM area only available when the edit ROM is used.

The ROM data is created using Speech LSI Utility.

Please refer to a "Code Option Setting Item" for details.

Sound code data configuration  
(when 30 phrases are selected)

0x00000	Sound control area
0x001FF	
0x00200	
0x159FF	Sound data area / Edit ROM area*1

Sound code data configuration  
(when 62 phrases are selected)

0x00000	Sound control area
0x003FF	
0x00400	
0x159FF	Sound data area / Edit ROM area*1

\*1: Edit ROM area depends on creation of the data

- Playback Time and Flash Capacity

The playback time depends on the memory capacity, sampling frequency, and the playback method. The equation to know the playback time is shown below. But this is not applied if the edit ROM function is used.

$$\text{Playback time [sec]} = \frac{1.024 \times (\text{Voice data area/Edit ROM area}) (\text{Kbit})}{\text{Sampling frequency [kHz]} \times \text{Bit length}}$$

(Bit length is 3.2 at the HQ-ADPCM, 4 at the 4-bit ADPCM2 and 8/16 at the PCM.)

In the case that the sampling frequency is 8 kHz, algorithm is HQ-ADPCM, the playback time is as follows.

When 30 phrases are selected

$$\text{Playback time} = \frac{1.024 \times 692 (\text{Kbit})}{8 (\text{kHz}) \times 3.2 (\text{bit})} \approx 27.6 [\text{sec}]$$

When 62 phrases are selected

$$\text{Playback time} = \frac{1.024 \times 688 (\text{Kbit})}{8 (\text{kHz}) \times 3.2 (\text{bit})} \approx 27.5 [\text{sec}]$$

Make the playback time of one phrase more than 20 msec.

- Edit ROM function

The edit ROM function makes it possible to play back multiple phrases in succession. The following functions are set using the edit ROM function:

- Continuous playback: There is no limit to set the number of times of the continuous playback. It depends on the Flash capacity only.
- Silence insertion function: 4 ms to 1,024 ms  
 \*Note: Silent insertion time varies for  $\pm 1$  ms depends on the sampling frequency.  
 An independent phrase generated by edit ROM shall be 20 ms or longer.

It is possible to use sound ROM effectively to use the edit ROM function.  
 An example of the ROM structure, in a case of using the edit ROM function is as follows.

Example 1) Phrases using the Edit ROM Function

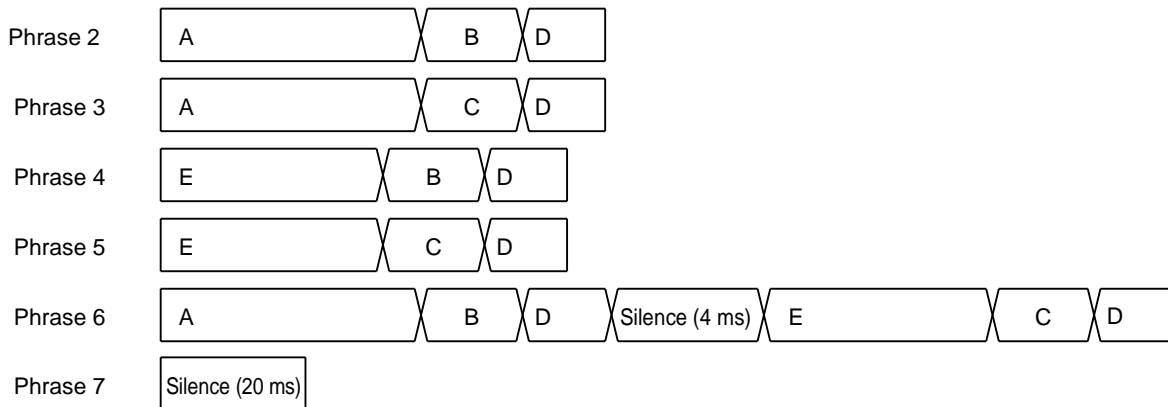

Example 2) Structure of the ROM storing contents of Example 1 (When 30 phrases are selected)

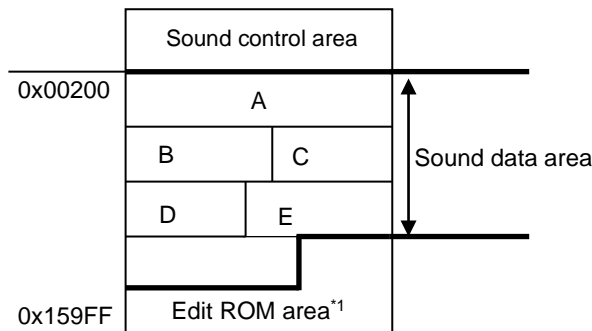

\*1 : Information on phrases 2 to 7 stored

- Playback mode setup  
Five playback modes are available. Can be set up for every phrase.  
Set when the sound code data is generated.

◆ Play Once mode

This mode is playback once.  
All the commands become invalid during playback.

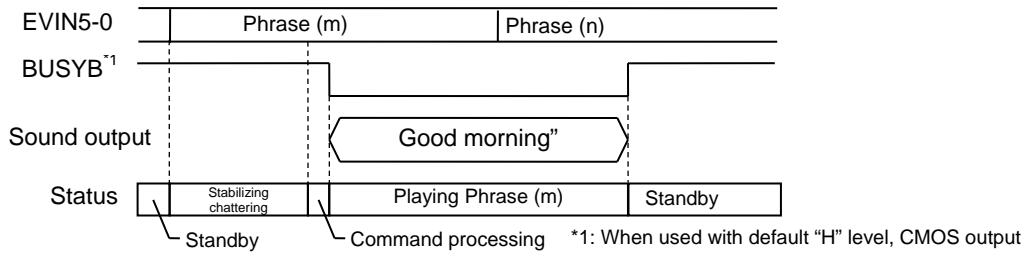

Next command must be input in the standby state after the playback ends.

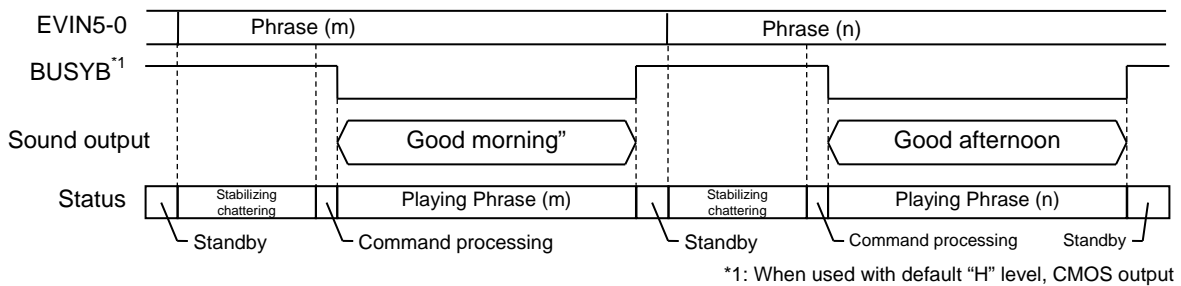

◆ Scheduled Play Once mode

This mode is playback once.  
When the next command is inputted during playback, after playback of the present phrase ends, playback of the next command starts.

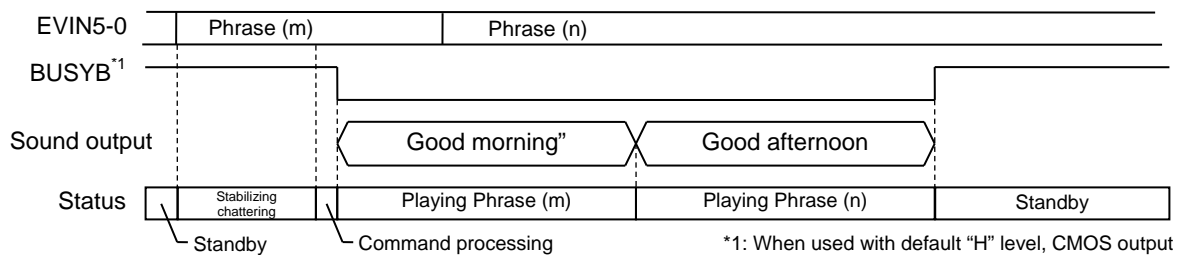

When a plurality of commands are inputted, the last command input at the end of the phrase is valid.  
In the following case, the phrase (n) is not played back because the last command is STOP command.

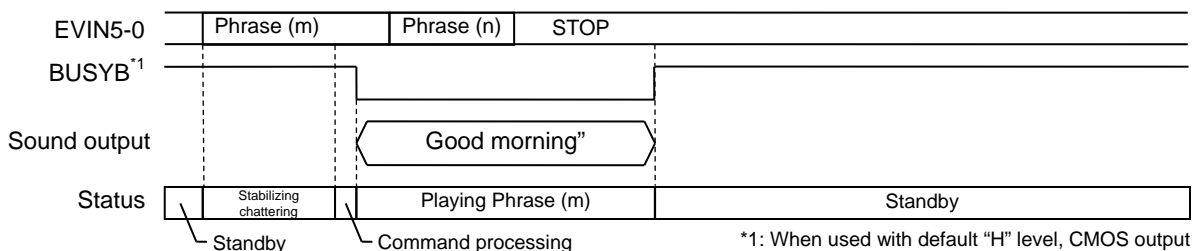

◆ Change Immediately Once mode

This mode is for playing back once.

When the following phrase is inputted into playback, playback of the present phrase is ended on the way, and playback of the following phrase starts.

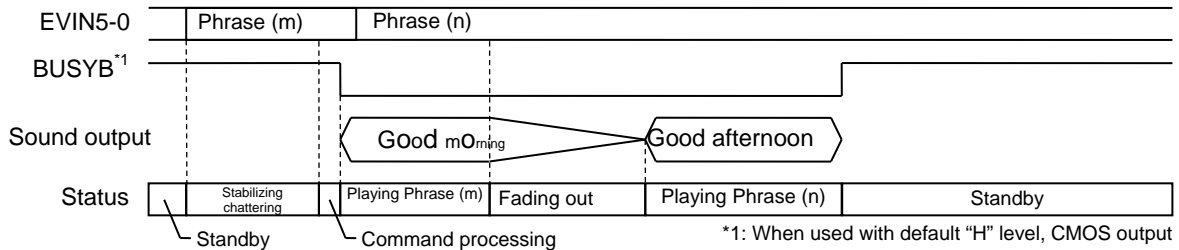

When a plurality of commands are inputted, the last command input at the end of the phrase is valid.

In the following case, the last input phrase (o) is played back.

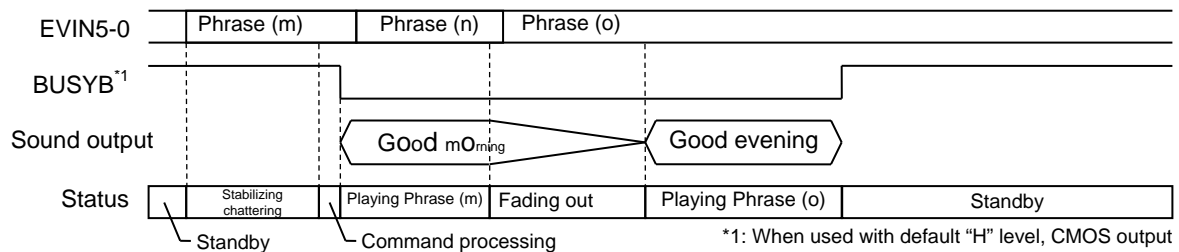

◆ Scheduled Play mode

Once the playback starts, it is repeated until the next command is input.

The next command input during the playback is executed after the playback ends.

When a plurality of commands are inputted, the last command input at the end of the phrase is valid, as in Scheduled Play Once.

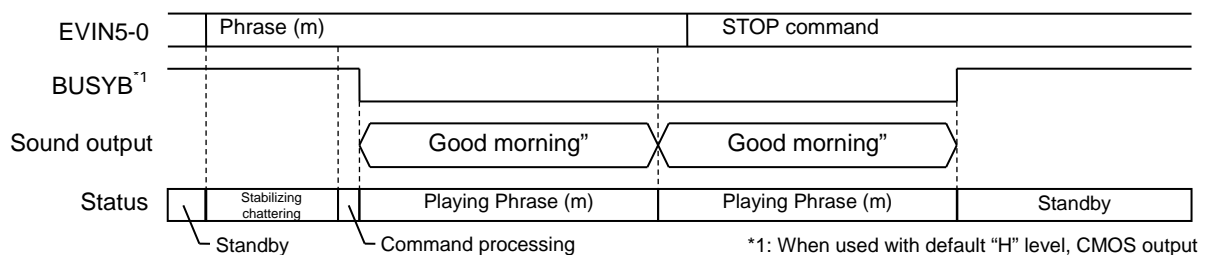

◆ Change Immediately mode

Once the playback starts, it is repeated until the next command is input.

When the next command is inputted, the phrase being played back is terminated, and the next command is executed.

When a plurality of commands are inputted, the last command input at the end of the phrase is valid, as in Change Immediately Once.

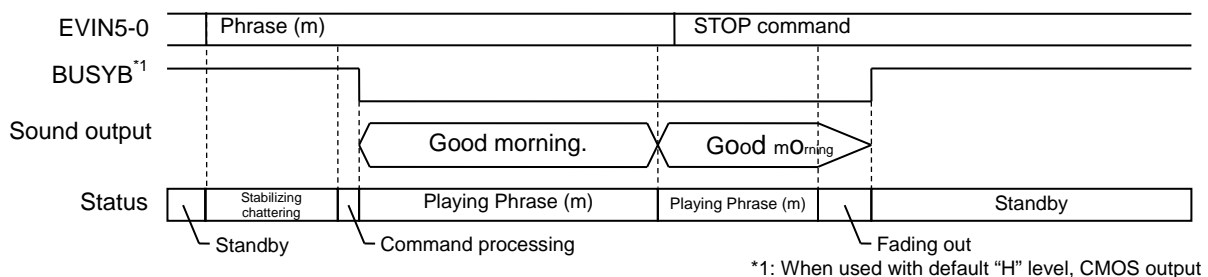

● Volume setup function

Each phrase can set up the volume setup.  
Set when the sound code data is generated.

Value	Volume [dB]	Value	Volume [dB]	Value	Volume [dB]
00h	+2.98	0Ah	-0.41	15h	-6.87
01h	+2.70	0Bh	-0.83	16h	-7.79
02h	+2.40	0Ch	-1.28	17h	-8.82
03h	+2.10	0Dh	-1.75	18h	-9.99
04h	+1.78	0Eh	-2.25	19h	-11.34
05h	+1.45	0Fh	-2.77	1Ah	-12.94
06h	+1.11	10h	-3.34	1Bh	-14.90
07h	+0.76	11h	-3.94	1Ch	-17.44
08h	+0.39	12h	-4.58	1Dh	-21.04
09h	+0.00	13h	-5.28	1Eh	-27.31
		14h	-6.04	1Fh	OFF

- Function of setting wait time before and after playback (WS1, WS2, WS3, WS4)

Wait time before playback (WS1, WS2) and after playback (WS3, WS4) can be set for each phrase.  
Set when the sound code data is generated.

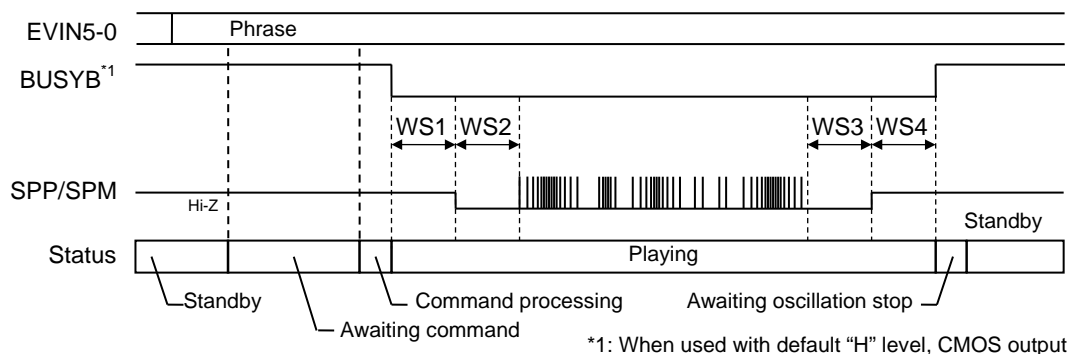

- WS1: Time after inputting a phrase address, until SPP/SPM pins are enabled.
- WS2: Time after SPP/SPM pins are enabled, until playback is started.
- WS3: Time after playback is completed, until SPP/SPM pins are disabled.
- WS4: Time after SPP/SPM pins are disabled, until it will be in a standby state.

WS1-WS4 can be arbitrarily set up between 0 to 1020 ms (4 ms unit).

• Speaker Pin Short Detection Function

The speaker pin short detection function detect the short-circuit between SPP pin and SPM pin, or between SPP/SPM pin and GND during playback.

When short-circuit of a speaker pin is detected, the playback will be stopped automatically, BUSYB pin will become "H" level, and LSI will become in a standby state.

Speaker short detection prevents IC destruction, but the detection circuit is effective to prevent destruction caused by sudden accidents, and is not intended for use in the condition like short detection occurs continuously.

This function can be set up with the option screen of Speech Utility.

Please refer to a "Code Option Setting Item" for details.

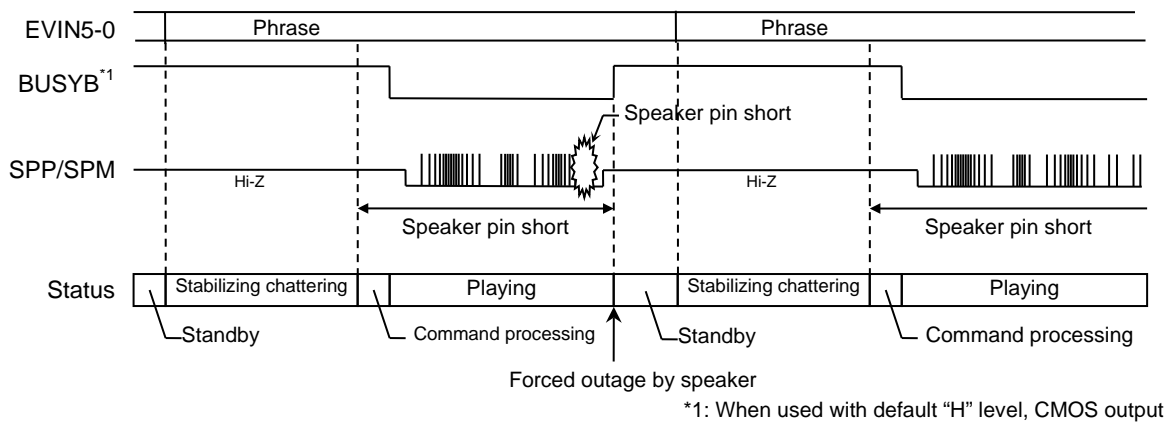



■ PLAYBACK COMMANDS

- Playback commands list

The following playback commands are used for the LSI. Use the playback commands in the condition ensuring that the sound code data is set on the flash memory of this LSI.

Command	Description
STOP	Stop command. The STOP command becomes effective for phrase other than those in Play Once mode and Scheduled Play Once mode.
DISCONNECT	Disconnection detection command. Speaker disconnection is detected. The STOP command must be input after using the DISCONNECT command.
PHRASE	Playback command. Playback phrase is selected from 30 phrases or 62phrases..

- Playback commands configuration

Control by EVIN4-0 and control by EVIN5-0 can be selected.

When the control by EVIN5-0 is selected, the number of phrases can be expanded to 62 phrases.

PHRASE command is allocated with a bit sequence other than the set values for STOP command and DISCONNECT command.

These are set when the sound code data is generated.

Please refer to a "Code Option Setting Item" for details.

The command configuration when the initial value (STOP command is set to be 00h and DISCONNECT command is set to be 01h) is set is as follows.

- (1) Control by EVIN4-0 (30 phrases)

Command	EVIN5	EVIN4	EVIN3	EVIN2	EVIN1	EVIN0
STOP	*	0	0	0	0	0
DISCONNECT	*	0	0	0	0	1
PHRASE	*	0	0	0	1	0
	:					
	*	1	1	1	1	1

\*: EVIN5 input is disabled.

- (2) Control by EVIN5-0 (62 phrases)

Command	EVIN5	EVIN4	EVIN3	EVIN2	EVIN1	EVIN0
STOP	0	0	0	0	0	0
DISCONNECT	0	0	0	0	0	1
PHRASE	0	0	0	0	1	0
	:					
	1	1	1	1	1	1

Any bit sequence can be set for STOP command and DISCONNECT command.

The following shows examples of a case where a non-initial value is set.

When STOP command is changed from the initial value, the number of phrase available decreases by one.

(1) Control by EVIN4-0 (when STOP command is set to be 1Fh and DISCONNECT command is set to be 01h)

Command	EVIN5	EVIN4	EVIN3	EVIN2	EVIN1	EVIN0
*1	*	0	0	0	0	0
DISCONNECT	*	0	0	0	0	1
PHRASE	*	0	0	0	1	0
	:					
	*	1	1	1	1	0
STOP	*	1	1	1	1	1

\*: EVIN5 input is disabled.

\*1: 00h cannot be set to PHRASE command. 29 phrases from 02h to 1Eh can be set to PHRASE command.

(2) Control by EVIN5-0 (when STOP command is set to be 3Eh and DISCONNECT command is set to be 02h)

Command	EVIN5	EVIN4	EVIN3	EVIN2	EVIN1	EVIN0
*1	0	0	0	0	0	0
PHRASE	0	0	0	0	0	1
DISCONNECT	0	0	0	0	1	0
PHRASE	0	0	0	0	1	1
	:					
	1	1	1	1	0	1
STOP	1	1	1	1	1	0
PHRASE	1	1	1	1	1	1

\*1: 00h cannot be set to PHRASE command. 61 phrases of 01h, 3Fh and from 03h to 3Dh can be set to PHRASE command.

• STOP command

EVIN5-0 pin	EVIN5	EVIN4	EVIN3	EVIN2	EVIN1	EVIN0
Initial value	0	0	0	0	0	0

The STOP command is used to stop the playback. BUSYB pin will become “H”, if the playback is stopped. The STOP command becomes effective for the phrase waiting to be played in Scheduled Play Once mode, and in Scheduled Play modem, Change Immediately Once mode, and Change Immediately mode. STOP command used for phrases played back in Play Once mode or Scheduled Play Once mode, the STOP is ignored. When STOP command is input in Scheduled Play mode, the playback stops after the phrase is played back to the end. When STOP command is input in Change Immediately Once mode or Change Immediately mode, the sound fades out, and the playback stops.

Operations where STOP command is effective are described below.

◆ STOP command operation in the case of Scheduled Play Once mode

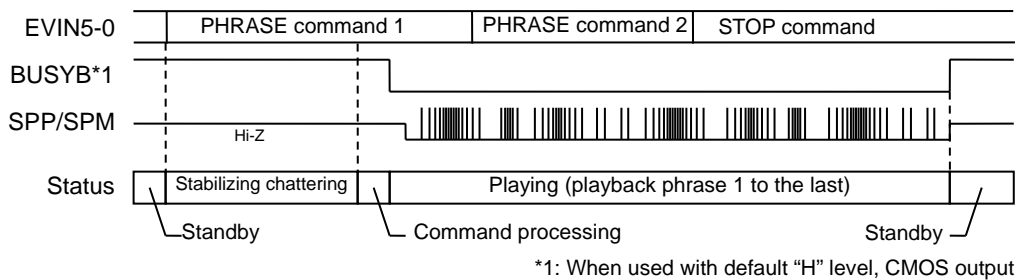

◆ STOP command operation in the case of Scheduled Play mode

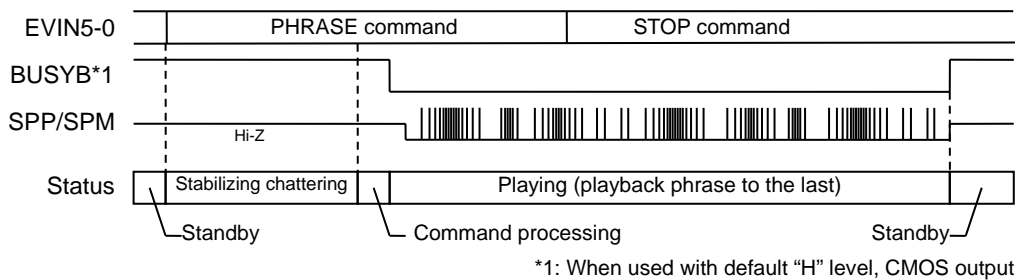

◆ STOP command operation in the case of Change Immediately Once mode or Change Immediately mode

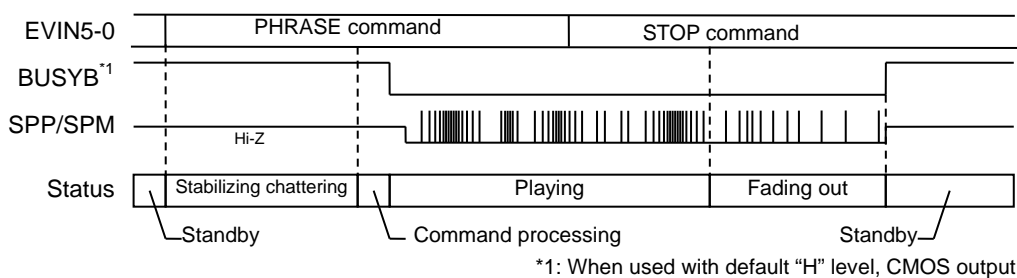

• DISCONNECT command

EVIN5-0 pin	EVIN5	EVIN4	EVIN3	EVIN2	EVIN1	EVIN0
Initial value	0	0	0	0	0	1

The DISCONNECT command is used to diagnose whether the speaker is disconnected or not. The command cannot be used during sound playback. The command shall be used during standby (no playback). Disconnection detection result is output to BUSYB pin. "L" is output when the speaker is disconnected, and outputs "H" when the speaker is not disconnected. Please input the STOP command to transition to standby state, after you use the DISCONNECT command.

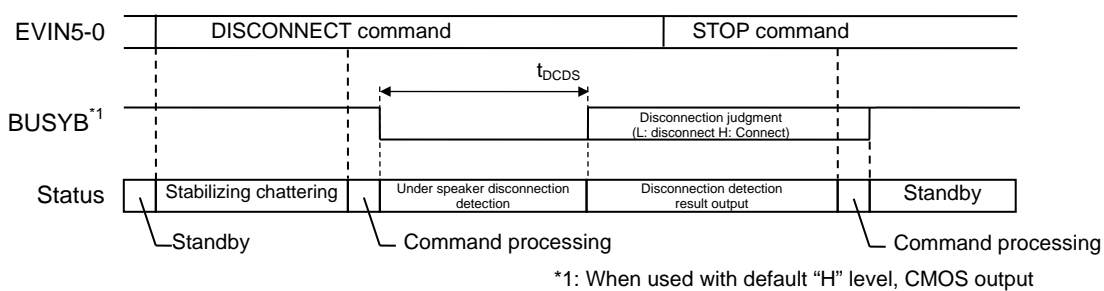

When no STOP command is input after the execution of DISCONNECT command, the disconnection detection automatically stops in one second, and transition to standby occurs.

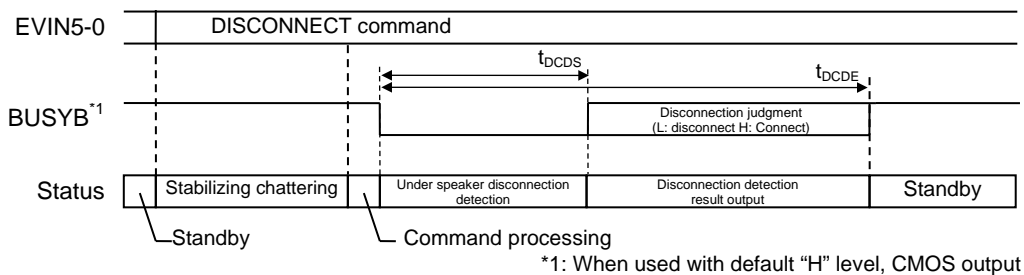

• PHRASE command

EVIN5-0 pin	EVIN5	EVIN4	EVIN3	EVIN2	EVIN1	EVIN0
	0	0	0	0	1	0
Initial value	:					
	1	1	1	1	1	1

PHRASE command is playback command. Specifies an address of a phrase to be played back. Command that is not set to be STOP command or DISCONNECT command is set to be PHRASE command. An address of phrase to be played back is set when sound code data is generated with Speech LSI Utility.

Timings of PHRASE command are shown below.

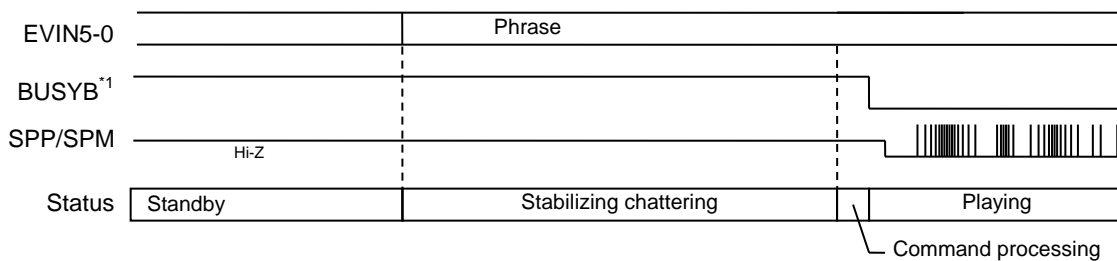

\*1: When used with default "H" level, CMOS output

Set the playback Phrase with EVIN4-EVIN0 or EVIN5-EVIN0.

(1) 1-byte command selection

No.	EVIN5	EVIN4	EVIN3	EVIN2	EVIN1	EVIN0	Playing Phrase
1	*	0	0	0	1	0	Phrase 2
:	*	:					:
30	*	1	1	1	1	1	Phrase 1F

\*: EVIN5 input is disabled.

(2) 2-byte command selection

No.	EVIN5	EVIN4	EVIN3	EVIN2	EVIN1	EVIN0	Playing Phrase
1	0	0	0	0	1	0	Phrase 2
:	:						:
62	1	1	1	1	1	1	Phrase 3F

■ TIMING DIAGRAMS

● Power-On Timing

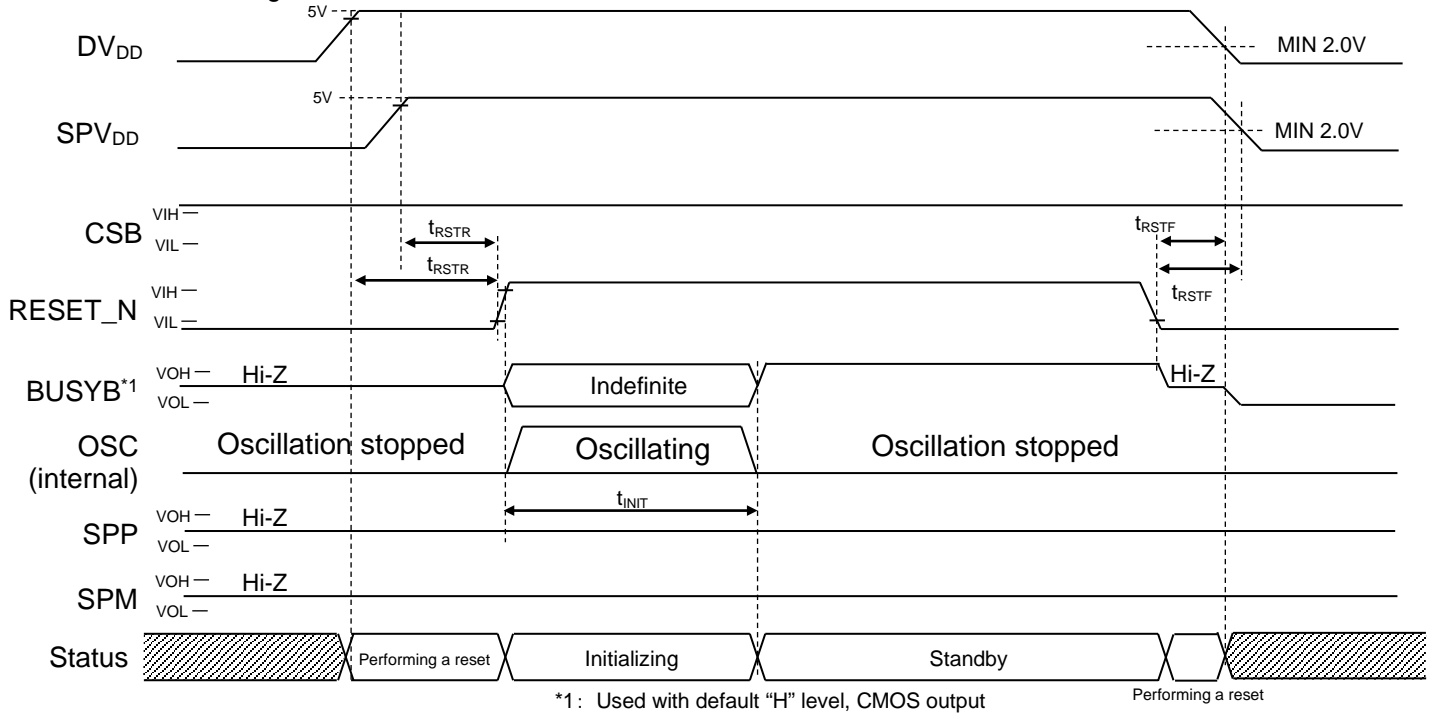

When the power is turned on and off, there is no restriction on the order of turning on DV<sub>DD</sub> and SPV<sub>DD</sub>. When DV<sub>DD</sub> or SPV<sub>DD</sub> falls below recommended operation power supply voltage range, "L" level must be input to RESET\_N pin.

● Power down timing (RESET\_N pin)

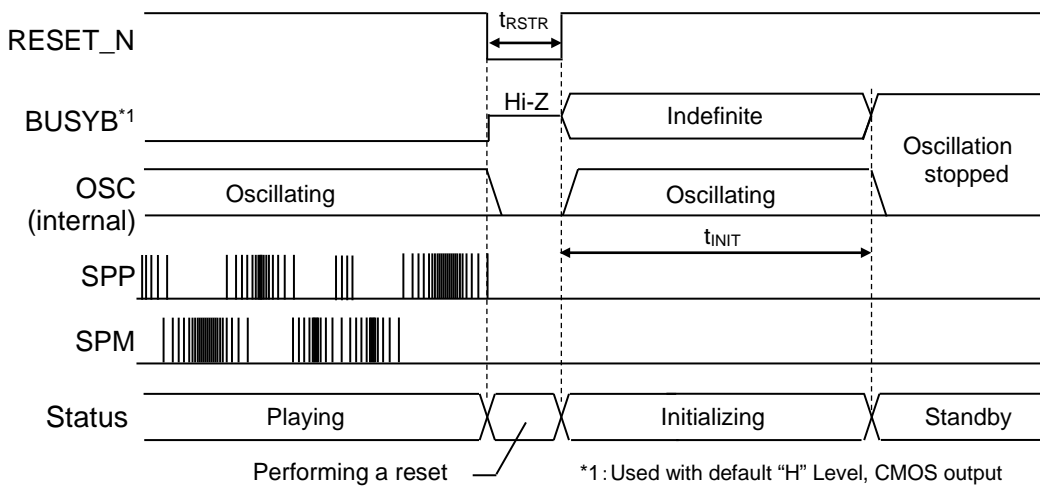

When DV<sub>DD</sub> or SPV<sub>DD</sub> falls below recommended operation power supply voltage range, "L" level must be input to RESET\_N pin.

• Play Once/Scheduled Play Once/Change Immediately Once mode timing

After playback of phrase (m) ends, playback request for next phrase (n) is accepted and the phrase (n) is played back. All the commands become invalid during playback of phrase (m).

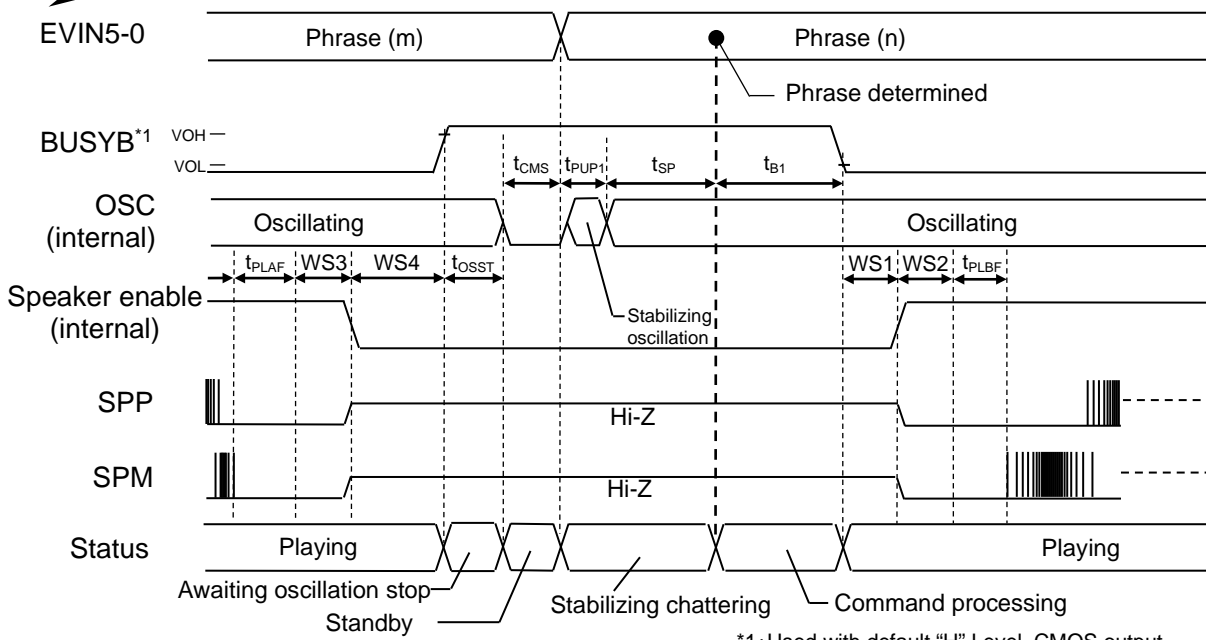
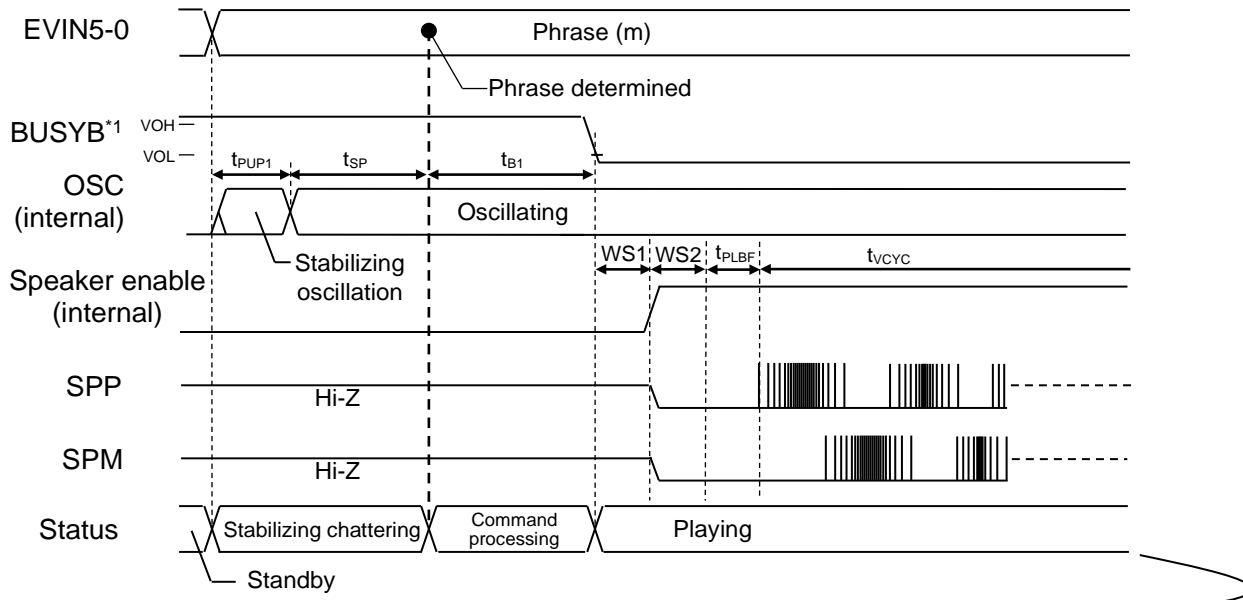

\*1: Used with default "H" Level, CMOS output

• Scheduled Play Once mode and Scheduled Play mode Timing (Continuous Play)

In response to playback request for the next phrase (n), the phrase (m) is played back to the end, and then playback of the phrase (n) starts.

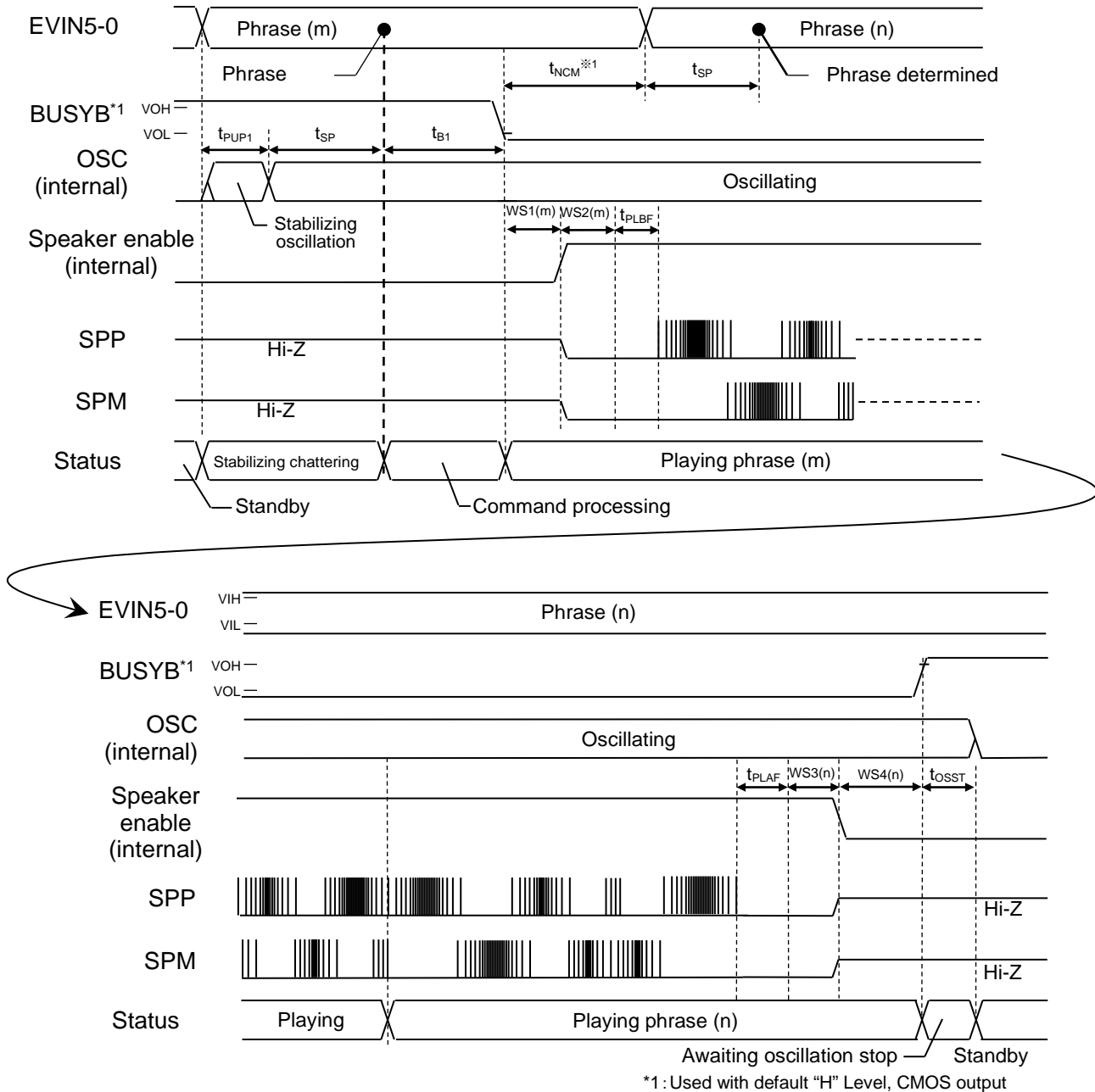

\*Under Scheduled Play mode, playback is stopped by STOP command.

Note 1: In Scheduled Play Once mode, the phrase (n) is played back immediately after the end of the playback of the phrase (m), in response to an input of a playback request (PHRASE command) for the next phrase (phrase (n)) within  $t_{NCM}$ .



- Change Immediately Once mode and Change Immediately mode Timing (Continuous Play)

In response to playback request for the next phrase (n), the phrase (m) is played back to the last, and then playback of the phrase (n) starts.

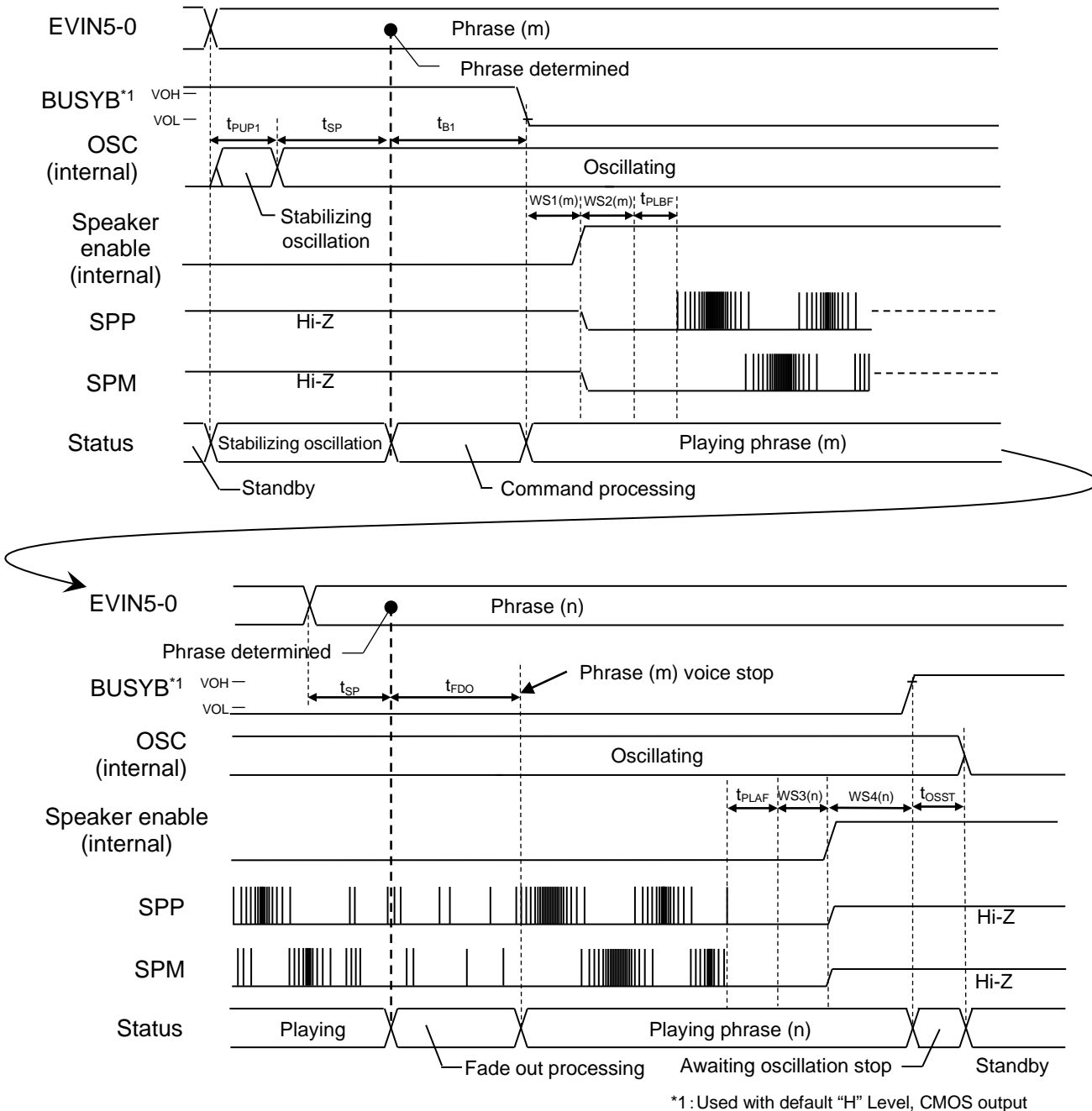

- Under Change Immediately mode, playback is stopped by STOP command.

- Scheduled Play Once mode and Scheduled Play mode Timing sound stop timing

After STOP command is input, the phrase is played back until the end, and the playback stops.

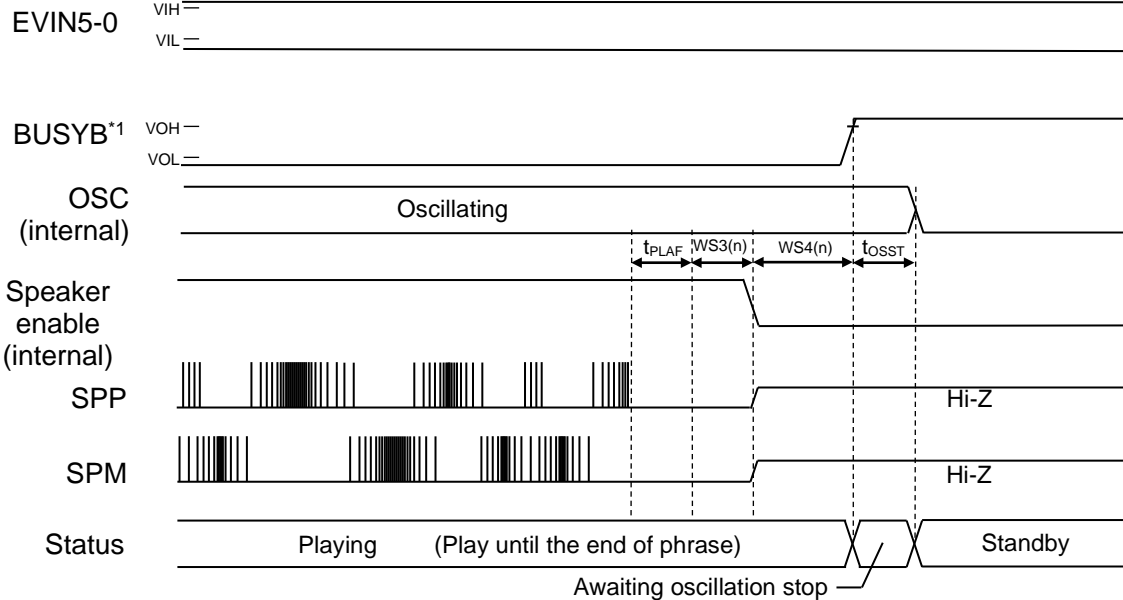
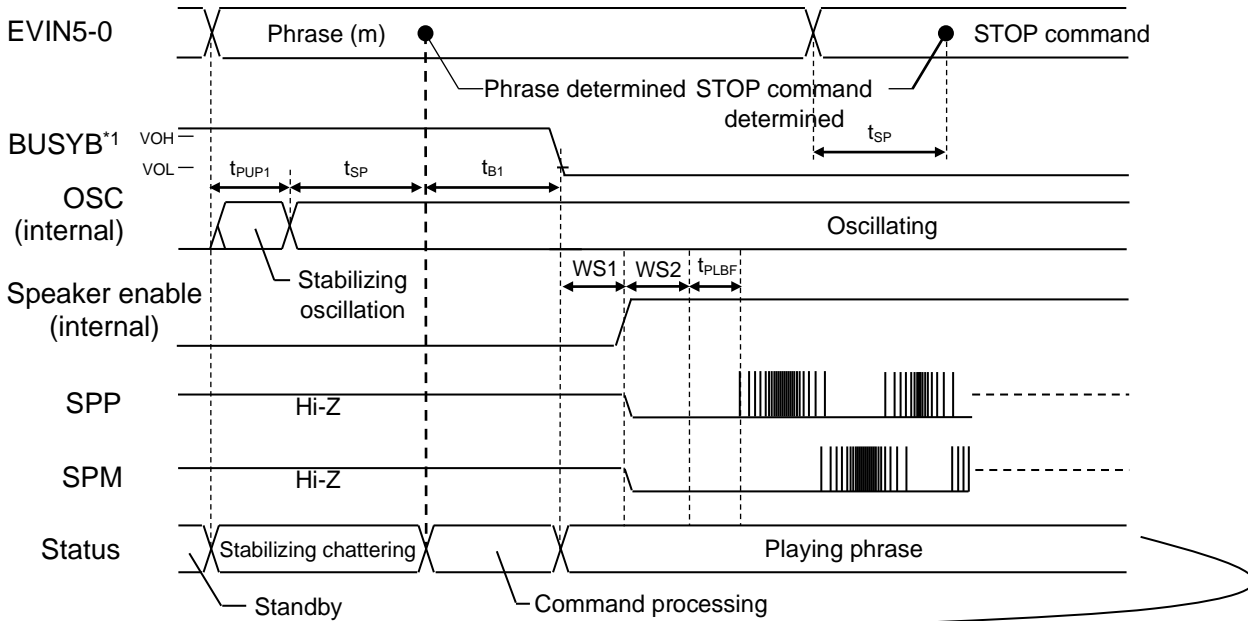

\*1: Used with default "H" Level, CMOS output

- Change Immediately Once mode and Change Immediately mode sound stop timing

After STOP command is input, the sound fades out, and the playback stops.

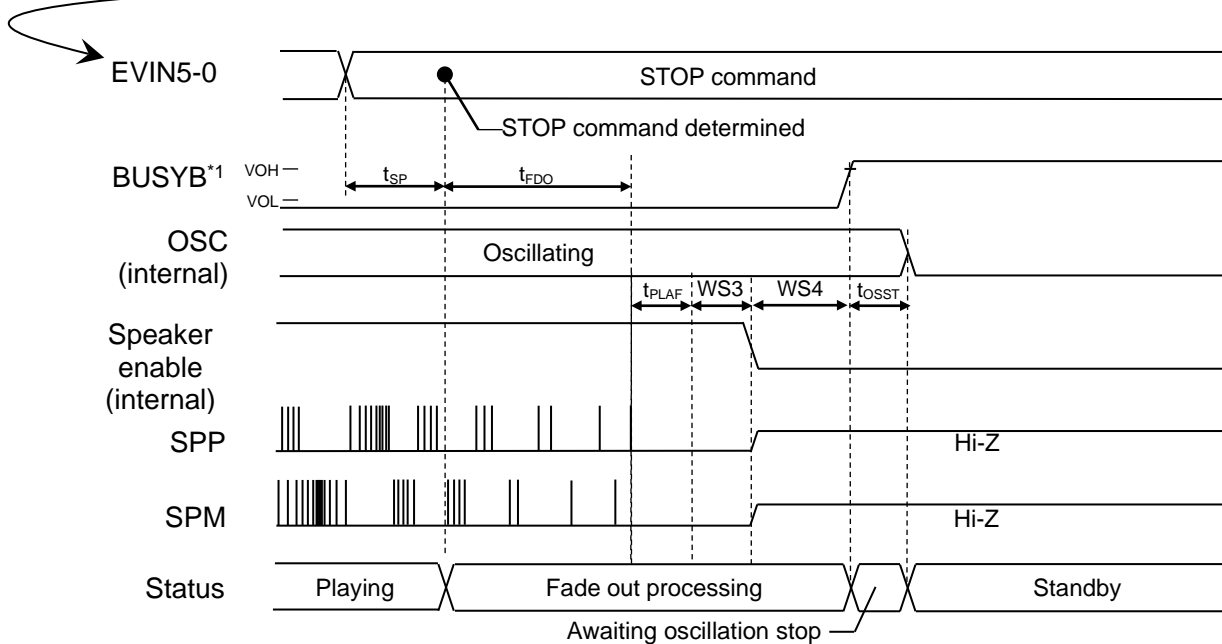
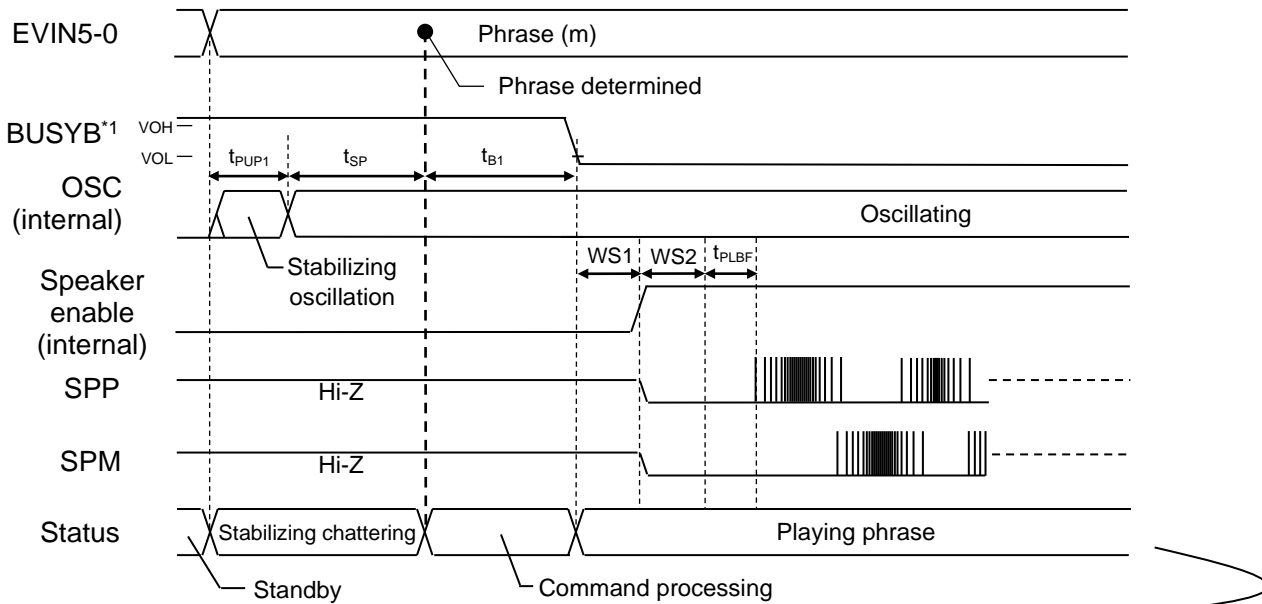

\*1 : Used with default "H" Level, CMOS output

• Disconnection detection timing

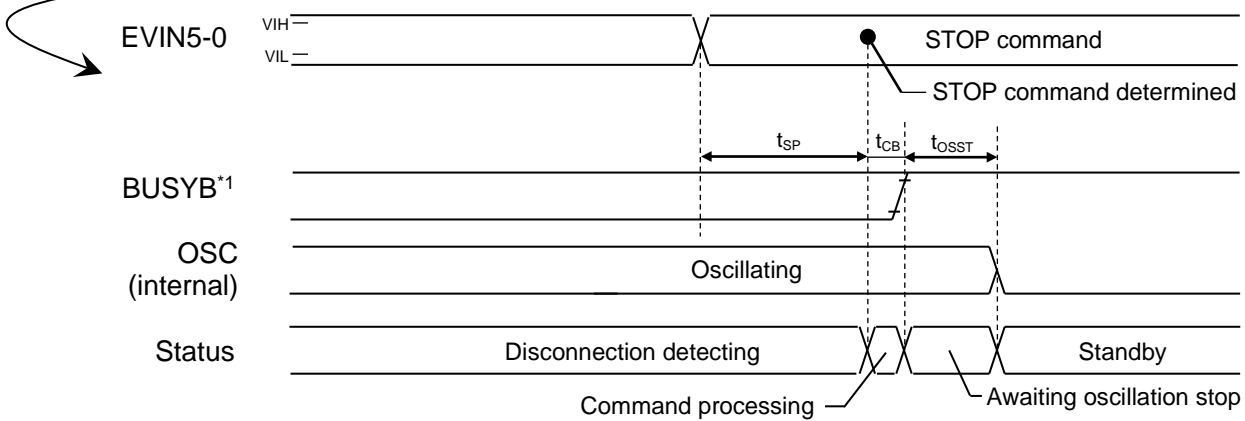
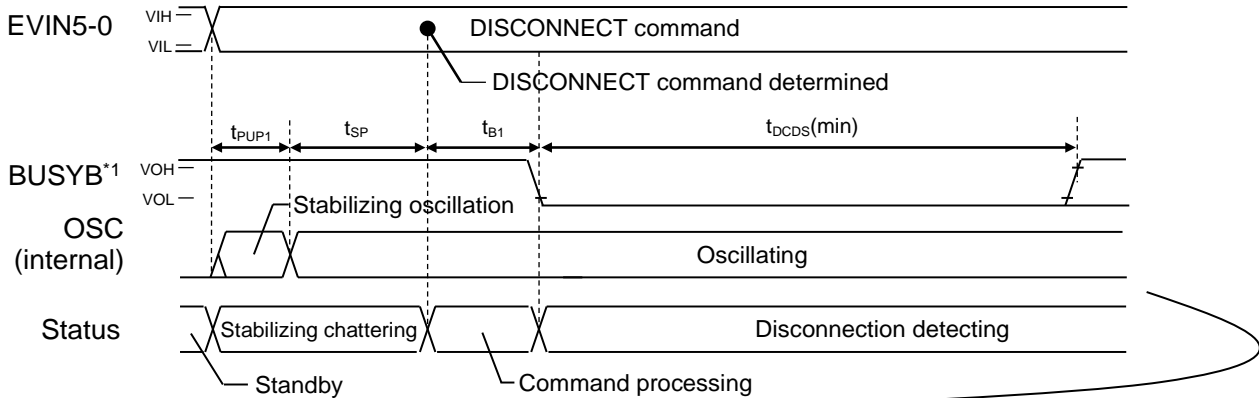

\*1 : Used with default "H" Level, CMOS output

• Speaker short detection timing

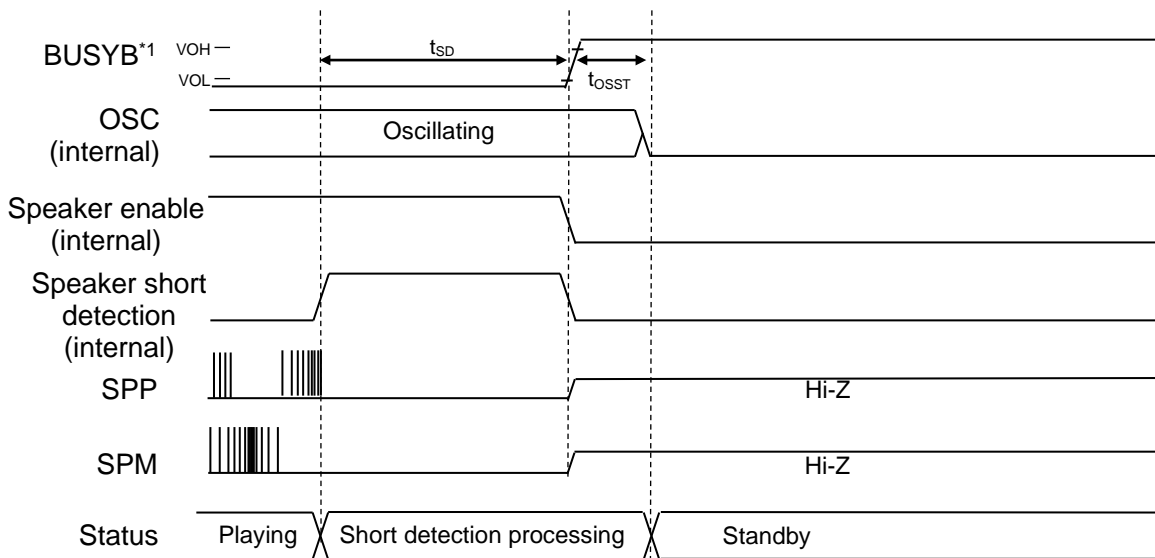

\*1 : Used with default "H" Level, CMOS output

## ■ Code Option Setting Item

Items set on Code Option Setting screen for Speech LSI Utility are as follows.

### •Speaker pin short detection function

Use of speaker pin short detection function	<input type="checkbox"/> (Not used)
	<input type="checkbox"/> (Used)

### •Num of Phrases and Command type setting

Num of Phrases / Command type	<input type="radio"/> 30 phrases / EVIN4-0 (30 phrases can be played and communicate with EVIN4-0 pins)
	<input type="radio"/> 62 phrases / EVIN5-0 (62 phrases can be played and communicate with EVIN5-0 pins)

STOP/DISCONNECT Command	Command bit sequence	
<input type="radio"/> Standard	STOP command	Set 00h
	DISCONNECT command	Set 01h
<input type="radio"/> Custom	STOP command	Set any bit sequence
	DISCONNECT command	Set any bit sequence (Set value different from STOP command)

### •BUSYB Pin Setting

Use of BUSYB	Initial State	Condition	BUSYB pin status
<input type="checkbox"/> (Not used)	<input type="radio"/> L level Output	*	Fixed to "L" output
	<input type="radio"/> H level Output	*	Fixed to "H" output
<input type="checkbox"/> (Used)	<input type="radio"/> L level Output	<input type="radio"/> CMOS	Output initial value "L" with CMOS output
		<input type="radio"/> Nch Open Drain	Output initial value "L" with Nch open drain output
		<input type="radio"/> Pch Open Drain	Output initial value HiZ with Pch open drain output
		<input type="radio"/> Hi-Z	Hiz output
	<input type="radio"/> H level Output	<input type="radio"/> CMOS	Output initial value "H" with CMOS output
		<input type="radio"/> Nch Open Drain	Output initial value HiZ with Nch open drain output
		<input type="radio"/> Pch Open Drain	Output initial value "H" with Pch open drain output
		<input type="radio"/> Hi-Z	Hiz output

\*: Setting value invalid

### •EVIN5 to EVIN0 Pins Setting

EVIN5-0	<input type="radio"/> Hi-Z	Used with high impedance input
	<input type="radio"/> Pull Down	Used with pull-down input
	<input type="radio"/> Pull-up	Used with pull-up input

When 30 phrases / EVIN4-0 is selected, EVIN5 input is disabled.

### •Chattering removal time setting

Chattering removal time	Set chattering removal time within a range of 2 ms to 62 ms (initial value is 16 ms)
-------------------------	--------------------------------------------------------------------------------------

**■ Phrase information Setting Item**

The items to be set on the phrase info setting screen of Speech LSI Utility are as follows.

- Playback mode (EVENT Mode)  
Set playback mode suitable for target playback, with reference to “Playback mode” in FUNCTIONAL DESCRIPTION.
- Volume setup  
Set playback mode suitable for target playback, with reference to “Volume setup function” in FUNCTIONAL DESCRIPTION.
- Setting Wait time before and after volume playback (WS1,WS2,WS3,WS4)  
Set desired Wait time with reference to “Function of setting wait time before and after playback (WS1, WS2, WS3, WS4)”.

### ■ TERMINATION OF THE $V_{DDL}$ PIN

The  $V_{DDL}$  pin is the regulator output that is power supply pin for the internal logic circuits. Connect a capacitor between this pin and the ground in order to prevent noise generation and power fluctuation.

The recommended capacitance value is shown below. However, it is important to evaluate and decide using the own board.

Also, start the next operation after each output voltage is stabilized.

Pin	Recommended capacitance value	Remarks
$V_{DDL}$	$1\ \mu\text{F} \pm 30\%$	The larger the connection capacitance, the longer the settling time.

### ■ POWER SUPPLY WIRING

The power supplies of this LSI are divided into the following two:

- Power supply for logic circuitry (:  $DV_{DD}$ )
- Power supply for speaker amplifier (:  $SPV_{DD}$ )

The example of power connection is shown below

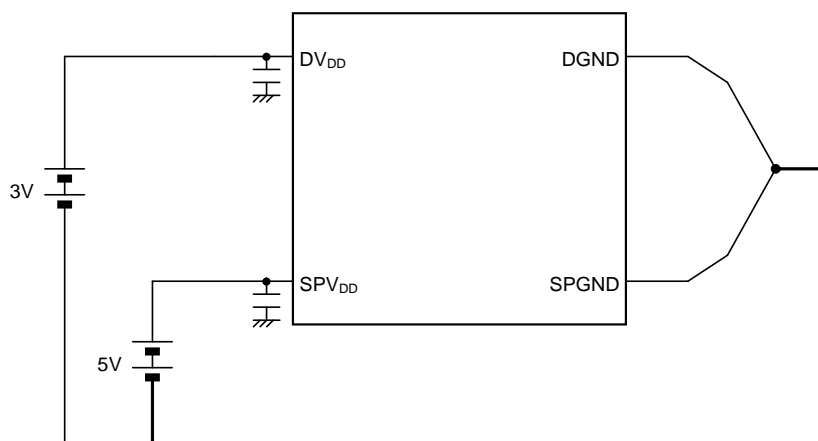
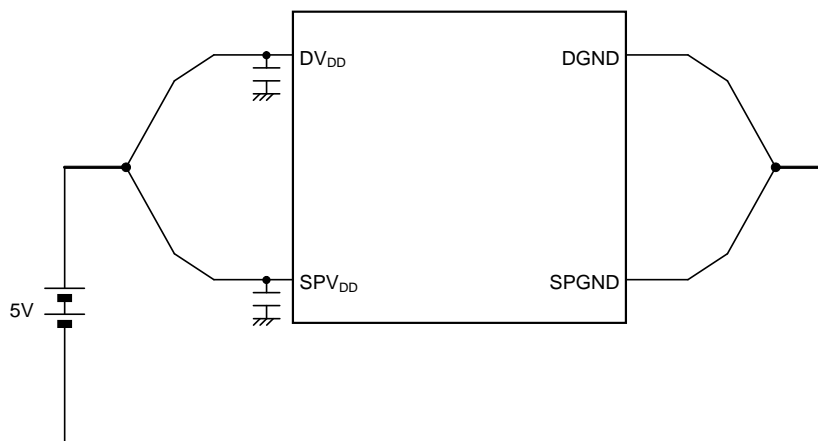

■ APPLICATION CIRCUIT

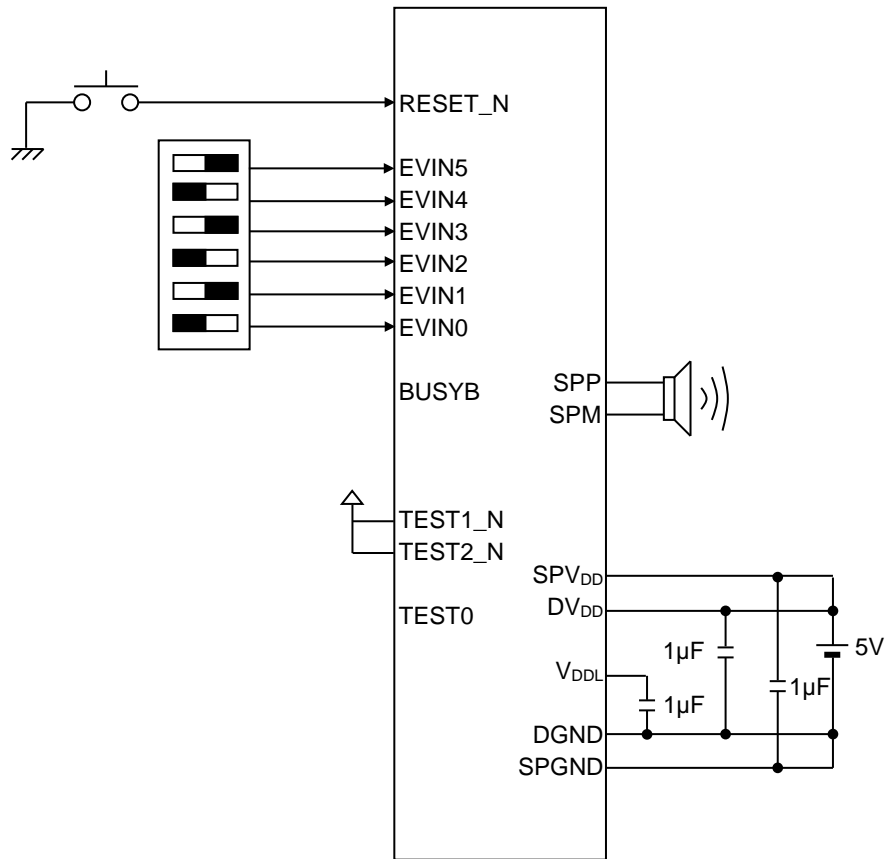



■ PACKAGE DIMENSIONS

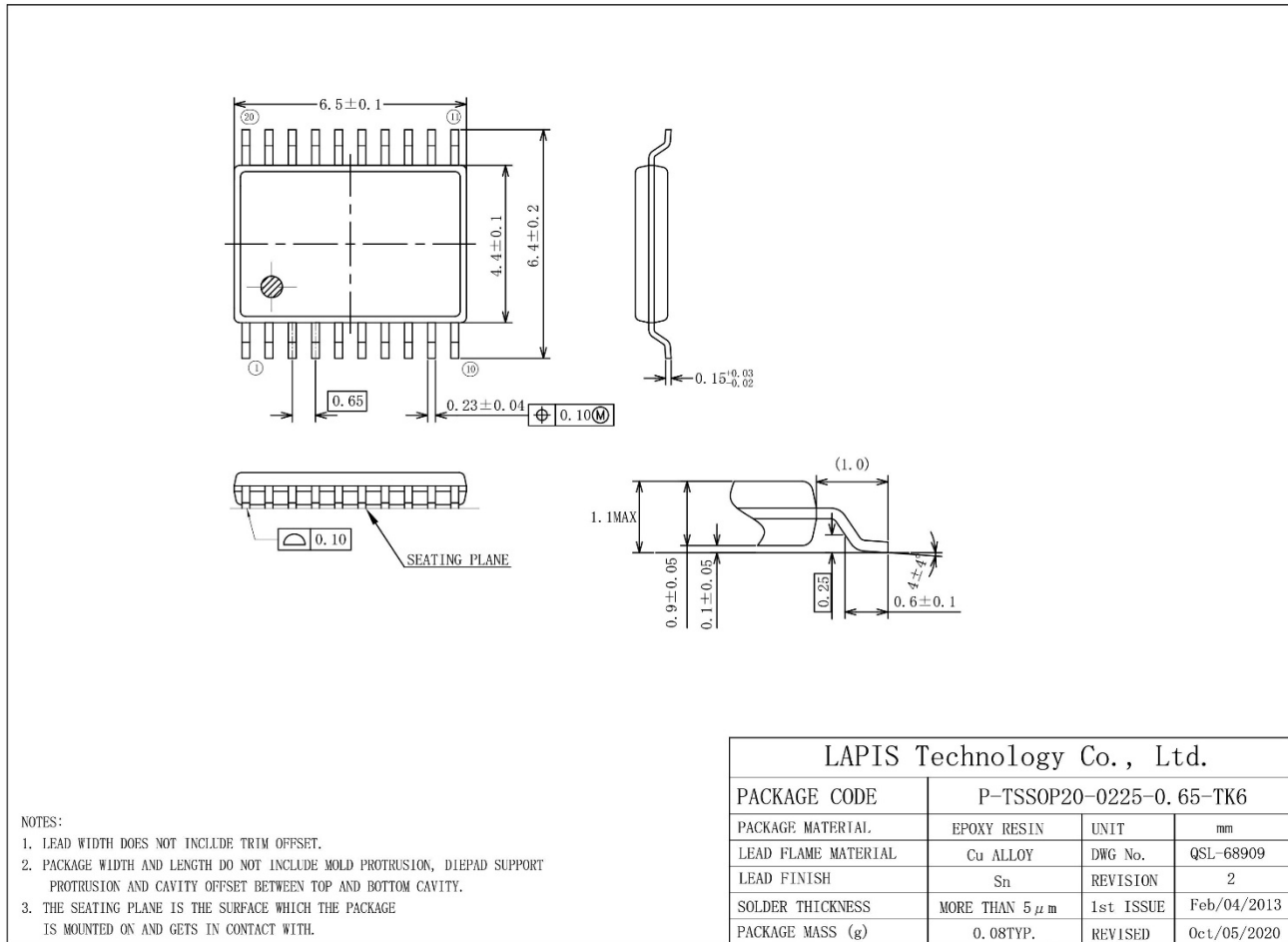

Notes for Mounting the Surface Mount Type Package

The surface mount type packages are very susceptible to heat in reflow mounting and humidity absorbed in storage. Therefore, before you perform reflow mounting, contact a ROHM sales office for the product name, package name, pin number, package code and desired mounting conditions (reflow method, temperature and times).

PCB Layer	JEDEC 4layers	JEDEC 2layers
PCB	(W/L/t= 76.2 / 114.3 / 1.6 (mm))	
Air cooling condition	Calm(0m/sec)	
Heat resistance( θ ja)	68.48[°C/W]	74.00[°C/W]
Heat resistance( θ jc)	0.61[°C/W]	0.61[°C/W]
Maximum power consumption of LSI (PMax) during 8Ω/1W speaker amp. output	0.3[W]	

TjMax of this LSI is 110 °C. TjMax is expressed with the following formulas.

$$TjMax = TaMax + \theta Ja \times PMax$$

## ■ REVISION HISTORY

Document No	Date	Page		Description
		Previous Edition	Current Edition	
FEDL22Q244-01	Jun. 15, 2021	—	—	Formal 1st edition.
FEDL22Q244-02	Jun. 20, 2022	8	8	Removed start time SPV <sub>DD</sub> after starting DV <sub>DD</sub> (t <sub>VDD</sub> )
		8	8	Added Oscillation stabilization time, t <sub>PUP1</sub> in AC Characteristics
		17	17	Added the note when using the playback commands
		29	29	Revised the description of STOP/DISCONNECT command
		33	33	Described heat resistance and TjMax of this LSI
—	35	Added "Notes for product usage"		

## Notes for product usage

### 1. HANDLING OF UNUSED INPUT PINS

Fix the unused input pins to the power pin or GND to prevent to cause the device performing wrong operation or increasing the current consumption due to noise, etc. If the handlings for the unused pins are described in the chapters, follow the instruction.

### 2. STATE AT POWER ON

At the power on, the internal setting and output of the ports are undefined until the power supply voltage reaches to the recommended operating condition and "L" level is input to the reset pin.

Be careful to design the application system does not work incorrectly due to the undefined data of internal setting and output of the ports.

### 3. CHARACTERISTICS DIFFERENCE BETWEEN THE PRODUCTS

Electrical characteristics, noise tolerance, noise radiation amount, and the other characteristics are different from each product.

When replacing from other product to LAPIS Technology products, please evaluate enough the apparatus/system which implemented LAPIS Technology products.

### 4. USE ENVIRONMENT

When using LAPIS Technology products in a high humidity environment and an environment where dew condensation, take moisture-proof measures.

Notes

- 1) The information contained herein is subject to change without notice.
- 2) When using LAPIS Technology Products, refer to the latest product information (data sheets, user's manuals, application notes, etc.), and ensure that usage conditions (absolute maximum ratings, recommended operating conditions, etc.) are within the ranges specified. LAPIS Technology disclaims any and all liability for any malfunctions, failure or accident arising out of or in connection with the use of LAPIS Technology Products outside of such usage conditions specified ranges, or without observing precautions. Even if it is used within such usage conditions specified ranges, semiconductors can break down and malfunction due to various factors. Therefore, in order to prevent personal injury, fire or the other damage from break down or malfunction of LAPIS Technology Products, please take safety at your own risk measures such as complying with the derating characteristics, implementing redundant and fire prevention designs, and utilizing backups and fail-safe procedures. You are responsible for evaluating the safety of the final products or systems manufactured by you.
- 3) Descriptions of circuits, software and other related information in this document are provided only to illustrate the standard operation of semiconductor products and application examples. You are fully responsible for the incorporation or any other use of the circuits, software, and information in the design of your product or system. And the peripheral conditions must be taken into account when designing circuits for mass production. LAPIS Technology disclaims any and all liability for any losses and damages incurred by you or third parties arising from the use of these circuits, software, and other related information.
- 4) No license, expressly or implied, is granted hereby under any intellectual property rights or other rights of LAPIS Technology or any third party with respect to LAPIS Technology Products or the information contained in this document (including but not limited to, the Product data, drawings, charts, programs, algorithms, and application examples, etc.). Therefore LAPIS Technology shall have no responsibility whatsoever for any dispute, concerning such rights owned by third parties, arising out of the use of such technical information.
- 5) The Products are intended for use in general electronic equipment (AV/OA devices, communication, consumer systems, gaming/entertainment sets, etc.) as well as the applications indicated in this document. For use of our Products in applications requiring a high degree of reliability (as exemplified below), please be sure to contact a LAPIS Technology representative and must obtain written agreement: transportation equipment (cars, ships, trains, etc.), primary communication equipment, traffic lights, fire/crime prevention, safety equipment, medical systems, servers, solar cells, and power transmission systems, etc. LAPIS Technology disclaims any and all liability for any losses and damages incurred by you or third parties arising by using the Product for purposes not intended by us. Do not use our Products in applications requiring extremely high reliability, such as aerospace equipment, nuclear power control systems, and submarine repeaters, etc.
- 6) The Products specified in this document are not designed to be radiation tolerant.
- 7) LAPIS Technology has used reasonable care to ensure the accuracy of the information contained in this document. However, LAPIS Technology does not warrant that such information is error-free and LAPIS Technology shall have no responsibility for any damages arising from any inaccuracy or misprint of such information.
- 8) Please use the Products in accordance with any applicable environmental laws and regulations, such as the RoHS Directive. LAPIS Technology shall have no responsibility for any damages or losses resulting non-compliance with any applicable laws or regulations.
- 9) When providing our Products and technologies contained in this document to other countries, you must abide by the procedures and provisions stipulated in all applicable export laws and regulations, including without limitation the US Export Administration Regulations and the Foreign Exchange and Foreign Trade Act..
- 10) Please contact a ROHM sales office if you have any questions regarding the information contained in this document or LAPIS Technology's Products.
- 11) This document, in part or in whole, may not be reprinted or reproduced without prior consent of LAPIS Technology.

(Note) "LAPIS Technology" as used in this document means LAPIS Technology Co., Ltd.

Copyright 2021-2022 LAPIS Technology Co., Ltd.

---

**LAPIS Technology Co.,Ltd.**

2-4-8 Shinyokohama, Kouhoku-ku, Yokohama 222-8575, Japan  
<https://www.lapis-tech.com/en/>